

P.C.B. LAND DIMENSION ± 0.05

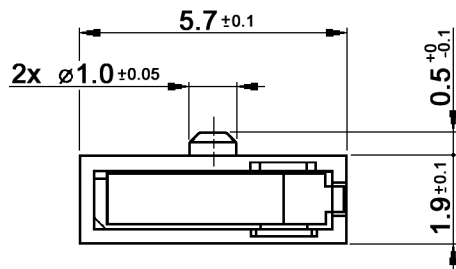

CIRCUIT DIAGRAM

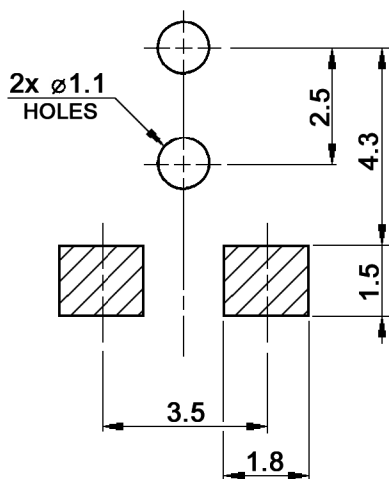
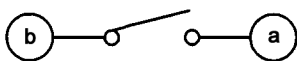

DEATAIL P

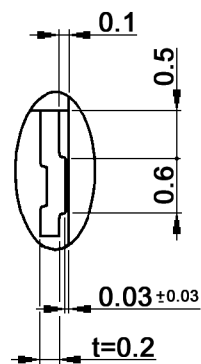

Compliance: RohS III (2015/863/EU)

Tolerances: up to 10: ±0.2mm above 10-50: ±0.3mm		Date	Name
		03/15	dr
Revised	12/21	dr	
Operating temperature	03/16	dr	
Mechanical life	11/15	dr	
Modifications	Date	Name	

DTS 208 CP R-T-1

knitter-switch

30 32 98

Page

1/3

Specifications:

Contact rating: 10mA, 5V DC (min. 0.1mA)
Contact resistance: 500mOhm max.
Insulation resistance: 100MOhm min. at 500V DC for 1 minute
Dielectric strength: 500V AC (50/60Hz, 2mA) for 1 minute
Operating temperature: -20°C to +70°C
Mechanical life: 100 000 cycles
Operating force: 28gf max.
Material: Contact clip: stainless steel, silver plated
 Terminal: brass strip, silver plated
 Case / slider: PA9T, black

Soldering conditions:

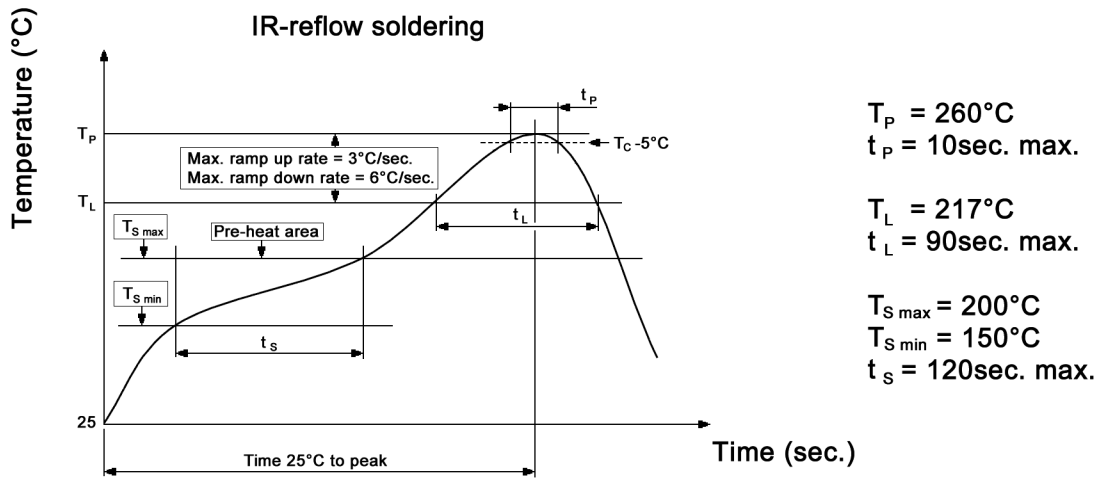

Compliance: RohS III (2015/863/EU)

Tolerances: up to 10: ±0.2mm above 10-50: ±0.3mm		Date	Name	<h1>DTS 208 CP R-T-1</h1>	
		03/15	dr		
Revised	12/21	dr	<h2>30 32 98</h2>	Page	
Operating temperature	03/16	dr		<h3>knitter-switch</h3>	2/3
Mechanical life	11/15	dr			
Modifications	Date	Name			

Packaging:

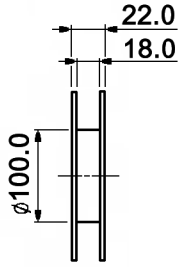
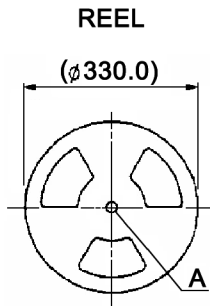

DETAIL A

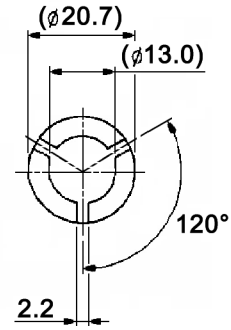

CARRIER TAPE

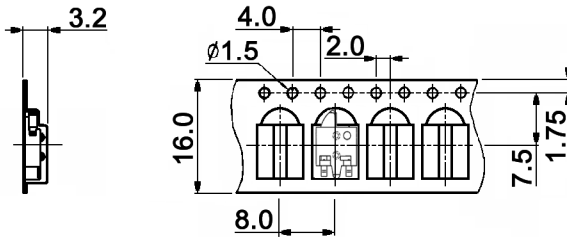

COVER TAPE



Packaging unit: 2500 pcs. / reel

Compliance: RohS III (2015/863/EU)

Tolerances: up to 10: \pm 0.2mm above 10-50: \pm 0.3mm	Date	Name
	03/15	dr
Revised	12/21	dr
Operating temperature	03/16	dr
Mechanical life	11/15	dr
Modifications	Date	Name

DTS 208 CP R-T-1

knitter-switch

30 32 98

Page

3/3