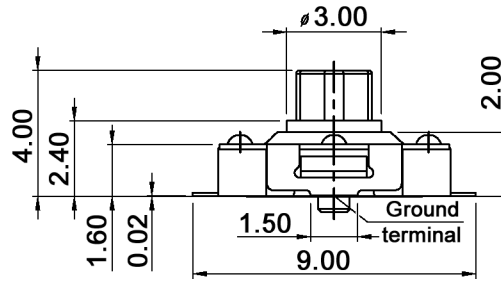
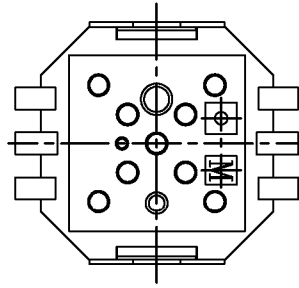
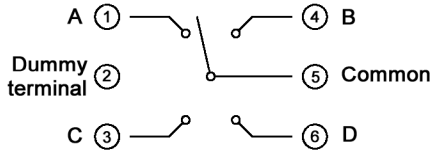
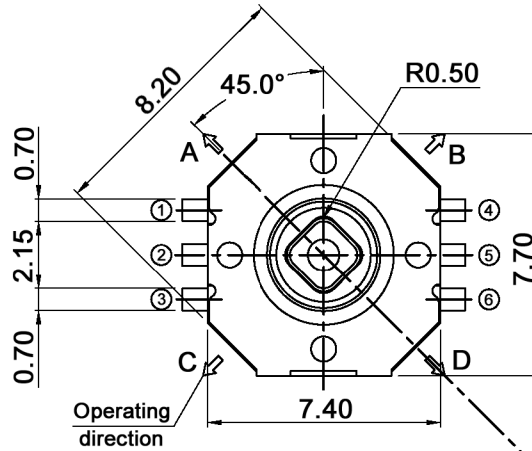
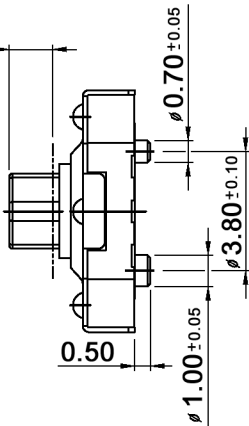

DIAGRAM CIRCUIT



1.40 max.
Fitting margin
for key top



P.C.B. LAYOUT

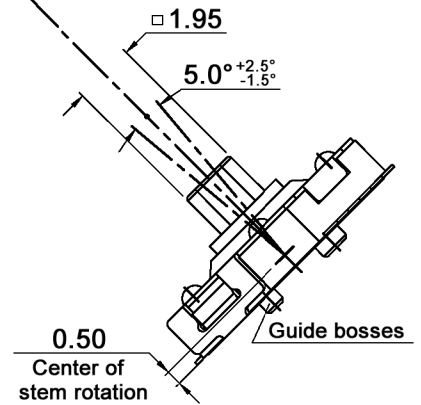
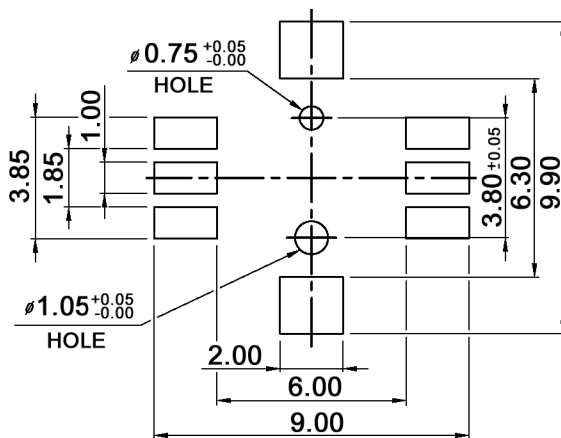

Compliance: RohS II (2011/65/EU)

Tolerances: max. ±0.20mm		Date	Name
		09/05	dr
Cycles	06/17	dr	
Revised	05/16	dr	
Operating temperature	07/15	dr	
Soldering conditions	11/13	dr	
Modifications	Date	Name	

TSSJ 4

knitter-switch

30 06 98

Page

1/2

Specifications:

Contact rating: 50mA, 12V DC
 Contact resistance: 100mOhm max.
 Insulation resistance: 100MOhm min.
 Dielectric strength: 250V AC (50 or 60 Hz) for 1 minute
 Operating temperature: -40°C to +85°C
 Storage temperature: -40°C to +85°C
 Mechanical life: 100 000 cycles min. (per direction)
 Operating force: 160 +/-50gf
 Stroke: 4 directions: 0.25 +0.1/-0.20mm
 Material: Cover: nickel plated
 Stem: high-temp. thermoplastic LCP
 Contact: stainless
 Terminal: brass, silver plated
 Base: high-temp. thermoplastic LCP, molded black

Soldering conditions:

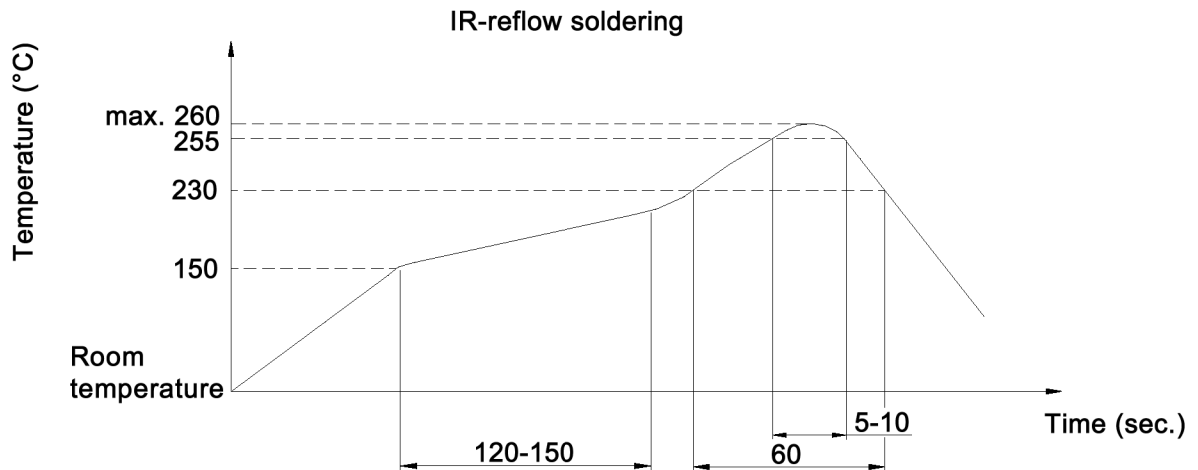

Compliance: RohS II (2011/65/EU)

Tolerances: max. ±0.20mm	Date	Name	TSSJ 4
	09/05	dr	
			30 06 98
			Page
			2/2
Modifications	Date	Name	