

CIRCUIT DIAGRAM

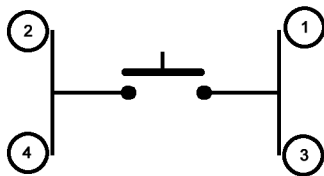

P.C.B. MOUNTING

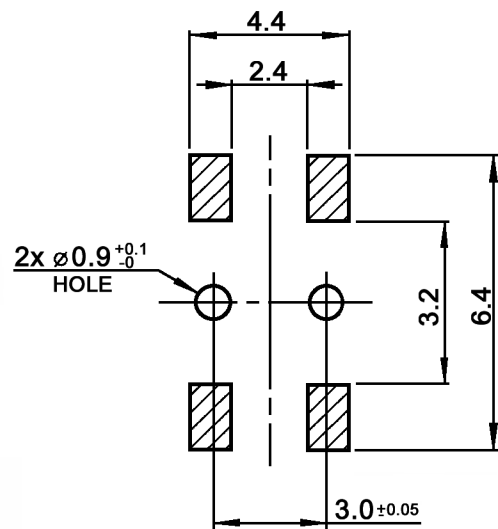

Compliance: RohS III (2015/863/EU)

Tolerances: ±0.2mm			Date	Name
Operating force	11/22	dr	09/10	dr
UL for plastics	10/19	dr		
Operating force	06/16	dr		
Pick & place-tab	02/16	dr		
Revised	08/15	dr		
Soldering conditions	10/14	dr		
Modifications	Date	Name		

**TSS 313-x T-RA**

**knitter-switch**

**30 21 78**

Page

1/3

**Specifications:**

**Contact rating:** 0.05A (max.), 12V DC  
**Contact resistance:** 500mOhm max.  
**Insulation resistance:** 100MOhm min. at 100V DC for 1 minute  
**Dielectric strength:** 250V AC (50/60Hz, 2mA) for 1 minute  
**Operating temperature:** -40°C to +85°C  
**Mechanical life:** 50 000 cycles  
**Material:** Terminal: brass, silver plated  
Case: LCP, Polyplastics Vectra 130i, UL94V-0, black, E106764  
Contact: stainless steel, silver plated  
Cover: stainless steel, washing  
Stem: PA46, DSM Stanyl TW241F, UL94HB, blue, E47960  
Tape: polyimide, yellow

**Soldering conditions:**

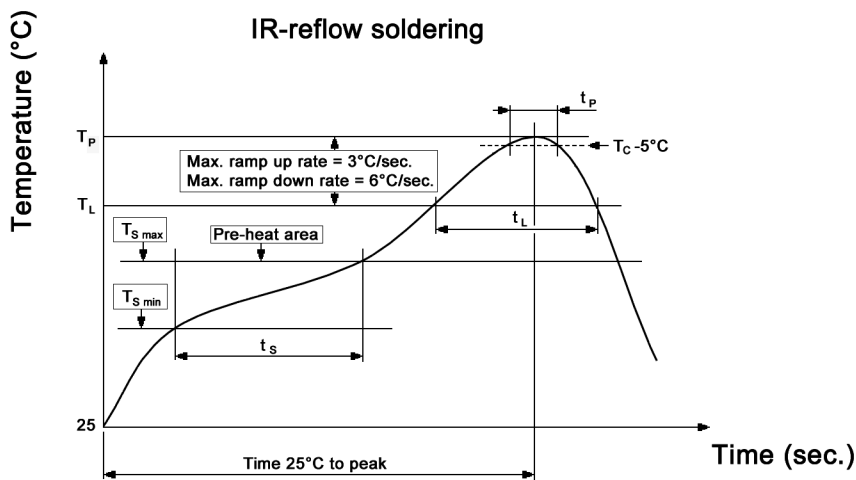

$T_p = 260^\circ\text{C}$   
 $t_p = 10\text{sec. max.}$   
  
 $T_L = 217^\circ\text{C}$   
 $t_L = 90\text{sec. max.}$   
  
 $T_{S\text{ max}} = 200^\circ\text{C}$   
 $T_{S\text{ min}} = 150^\circ\text{C}$   
 $t_S = 120\text{sec. max.}$

x	Operating force
160	160 +/-50gf
200	200 +/-60gf
empty	250 +/-70gf

Compliance: RohS III (2015/863/EU)

Tolerances: ±0.2mm		Date	Name	<h1>TSS 313-x T-RA</h1>
		09/10	dr	
Operating force	11/22	dr		
UL for plastics	10/19	dr		
Operating force	06/16	dr		
Pick & place-tab	02/16	dr		
Revised	08/15	dr	<b>knitter-switch</b>	<h2>30 21 78</h2>
Soldering conditions	10/14	dr		
Modifications	Date	Name		2/3

Packaging:

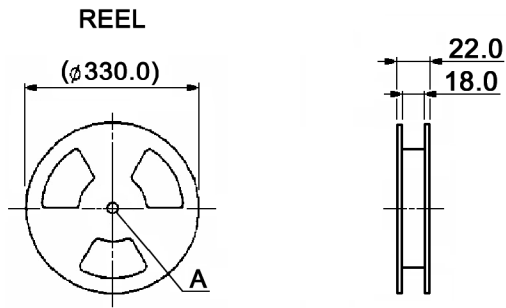

DETAIL A

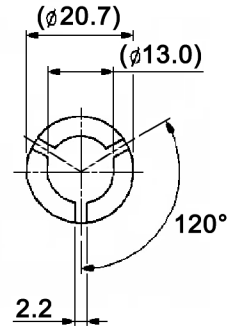

CARRIER TAPE

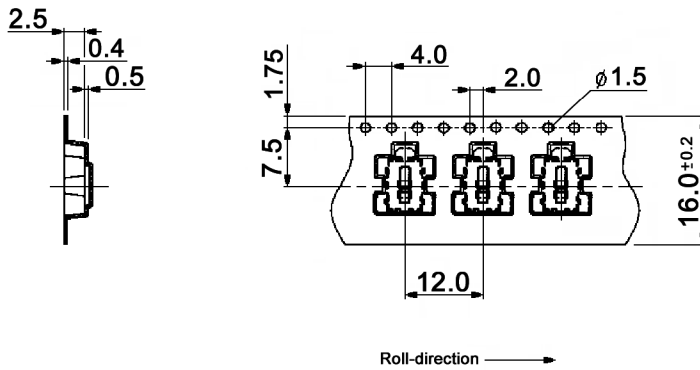

COVER TAPE

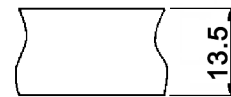

Packaging unit: 1 700 pcs. / reel  
Compliance: RohS III (2015/863/EU)

Tolerances: $\pm 0.2\text{mm}$			Date	Name	<h1>TSS 313-x T-RA</h1>
			09/10	dr	
Operating force	11/22	dr			
UL for plastics	10/19	dr			
Operating force	06/16	dr			<h2>30 21 78</h2>
Pick & place-tab	02/16	dr			
Revised	08/15	dr			
Soldering conditions	10/14	dr	<b>knitter-switch</b>		Page
Modifications	Date	Name			3/3