

Rubber Keypad Design

Tolerance Requirement of Silicone Rubber Key:

Dimensions:

0 – 9 mm	± 0.10 mm
10 – 19 mm	± 0.15 mm
20 – 29 mm	± 0.20 mm
30 – 39 mm	± 0.25 mm
40 – 49 mm	± 0.30 mm
50 – 59 mm	± 0.35 mm
60 and above	± 0.6 %

Actuation Force:

50 – 60 grams	± 15 grams
61 – 80 grams	± 20 grams
81 – 100 grams	± 25 grams
101 – 120 grams	± 30 grams
121 – 150 grams	± 35 grams
151 – 200 grams	± 40 grams
201 and above	± 25 %

Mechanical and Electrical Properties of Silicone Rubber:

Temperature for use:	–55 °C to +250 °C
Specific Gravity:	1.15
Tensile Strength:	90 Kg/cm ²
Tear Strength:	13 Kgf/cm
Compression Set:	10% (180 °C x 22 hrs.)
Elongation at Break:	350%
Volume Resistivity:	8 x 10 ¹⁴ Ω cm
Insulation Breakdown:	24 Kv/mm
Colour:	Colouring possible
Dielectric Constant:	4.2 (50 Hz)
Dielectric Tangent:	13% (50 Hz)

Depending on the size of contacts and keyboard layout.

Non-Conductive Silicone

Force-Stroke Curve of Rubber Keypad

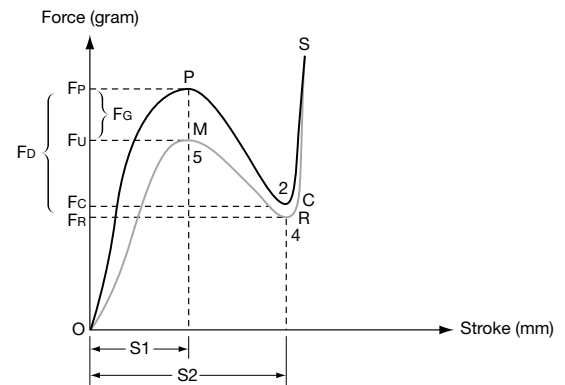

Force

Fp	Peak Force (Fmax)
Fu	Max. Return Force
Fc	Contact Force
Fr	Min. Return Force (Fmin)
Fm	Max. Return Force
Fd	Drop Force (Fd = Fp – Fc)
Fg	Gap Force (Fg = Fp – Fm)

Stroke

S1	Peak Stroke
S2	Contact Stroke

Location:

O	Original Point
P	Peak Point
C	Contact Point
R	Return Point
M	Max. Return Point

Travel

O–P	Peak Force (FMAX)
P–C	Contact Force
C–S	Min. Return Force (FMIN)
S–R–M–O	Gap Force (FG = Fp – Fm)

Basic Construction

Illustration:

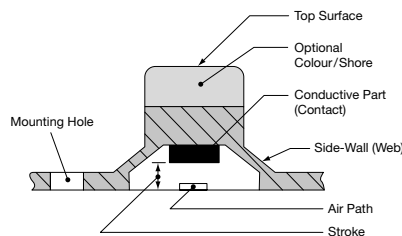

Life Test:

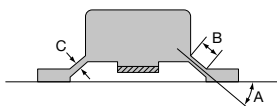

Operating life depends on:

- **Soft Material** ... 50 Shore is preferred.
- **Low Stroke** ... less than 1 mm
- **Angle** (as part A illustrated above) ... 40-degree is recommended.
- **Length of side-wall** ... (as part B illustrated above)
- **Thickness of side-wall** ... (as part C illustrated above) ... determined by key structure. The thicker the web, the higher the operating force.

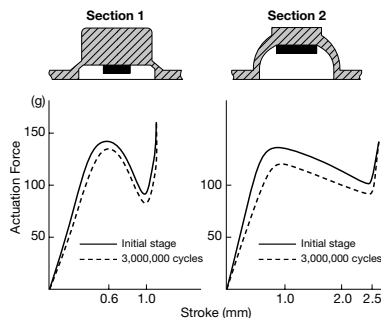



Rubber Keypad Design

Typical Key Sections and Characteristics:

Force Range: 30 ~ 350 grams
 Stroke Range: 0.5 ~ 3.0 mm
 Cycle Life (x10³): 500 ~ 2000
 Typical uses: Telephone, Remote Control, Automotive, Radio, Toys, Calculator, etc.

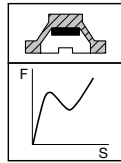

Force Range: 30 ~ 80 grams
 Stroke Range: 2.0 ~ 4.0 mm
 Cycle Life (x10³): 5000 ~ 20000
 Typical uses: Computer, Typewriter etc.

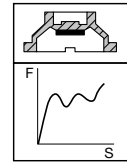

Force Range: 30 ~ 250 grams
 Stroke Range: 0.7 ~ 2.5 mm
 Cycle Life (x10³): 1000 ~ 3000
 Typical uses: Telephone, Remote Control, Toys, Games, Calculator, etc.

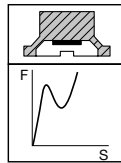

Force Range: 30 ~ 200 grams
 Stroke Range: 1.0 ~ 2.5 mm
 Cycle Life (x10³): 500 ~ 3000
 Typical uses: Telephone, Typewriter, Test Instruments, etc.

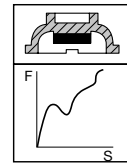

Force Range: 30 ~ 150 grams
 Stroke Range: 0.5 ~ 3.0 mm
 Cycle Life (x10³): 1000 ~ 3000
 Typical uses: Telephone, Remote Control, Toys, Measuring Instruments, Office Machine

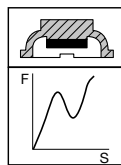

Force Range: 20 ~ 80 grams
 Stroke Range: 0.2 ~ 1.0 mm
 Cycle Life (x10³): 500 ~ 10000
 Typical uses: Typewriter, Household Appliances, Computer, etc.

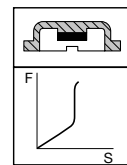

Some Special Design Illustrations:

1. Different shorehardnesses in the basic keypad and key

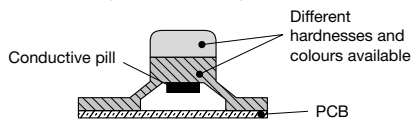

2. Push or pull thru to anchor keypad to PCB

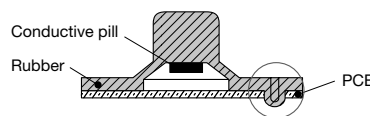

3. Back lighting – option 1

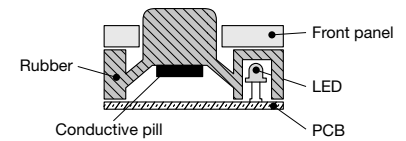

4. Squared key top design with LED light pipe

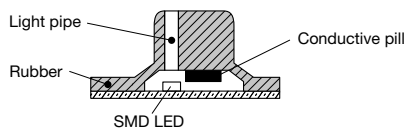

5. Back lighting – option 2

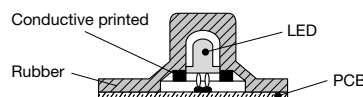

6. Control of travel distance

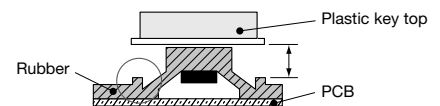

Special Design for Construction Ideas:

1. Typical outside radius is 1.0 mm to 1.5 mm.
2. Minimum radius is 0.3 mm.
3. Minimum inside radius is 0.2 mm.
4. Spacing between the edges of a rubber dome and a guide hole is 1.0 mm or more.
5. Guide holes are min. 1.0 mm in diameter.
6. The width of a rubber dome base is typically 2.0 mm more than a.
7. The minimum radius for the side edges of key top is 0.25 mm.
8. The minimum radius for the top edges of key top is 0.2 mm.

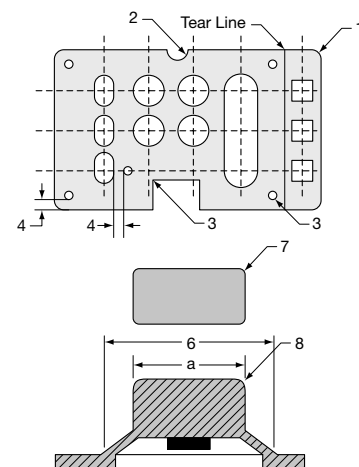

Rubber Keypad Design

Guideline for Assembly Design:

A & B: dimensions of plastic
a & b: dimensions rubber

$A-a \geq 0.5 \text{ mm}$, $B-b > 0.5 \text{ mm}$

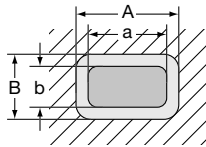

$D-d = 1.5 \text{ to } 2.0 \text{ mm}$

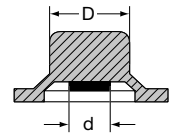

R: the corner radius of plastic
r: the corner radius of rubber

$1 \text{ mm} \leq R \leq 1.25 \text{ mm}$, $0.75 \text{ mm} \leq r \leq 1 \text{ mm}$ is better

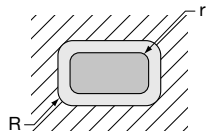

P: diameter of post
t: the gap between post & conductive pill

$P = 1.0 \text{ mm}$ is better
 $t = 0.1 \sim 0.15 \text{ mm}$ is better

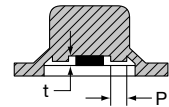

H: the dimension of key tops & plastic

S: the stroke of key pad

$H-S \leq 1.5 \text{ mm}$

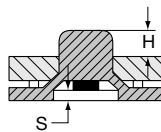

F_c : click force
 $F_1 - F_2 > 25 \text{ g}$ is better

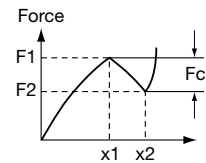

Guideline for Printing Artwork Design:

Button Graphics

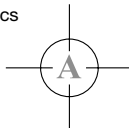

Graphics Off Centre $\pm 0.3 \text{ mm}$

Full Surface Printing

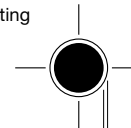

$\pm 0.5 \text{ mm}$
 0.5 mm

Patterns of Conductive Designs:

Items:

Circle:

Square/Ellipse:

Conductive Pill Resistance:

Mechanical Life:

Print type Resistance:

Mechanical Life:

Standard Sizes of Conductive Pill

1.5, 2, 2.5, 3, 3.5, 4, 4.5, 5, 6, 7, 8, 9, 10

Recommended size of conductive ink printing contact is flexible.

Less than 150 ohms, with 125 grams loading

minimum 10 million operations

Less than 500 ohms, with 125 grams loading

1×10^6 max. operations

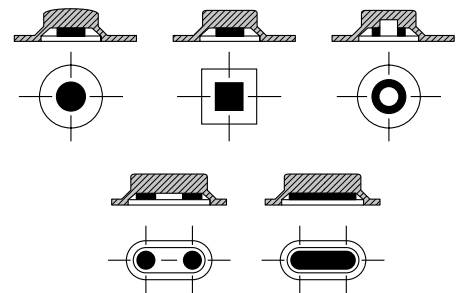

Colour/Printing:

Suitable Key Surface for Legend Printing:

The commonly used colour for the underlay is medium-grey. Customers should provide us with the Pantone code or a colour specimen for both the key button and the legend.

